

SETTING THE SHIFT STROKE OF 3RD - 4TH 'SHIFTER LEVER' or GEAR CHANGE LEVER IN MAZDA P66M MANUAL 6 SPEED TRANSMISSION.

INSTALLED IN NC MIATA MX-5 + 2009-2012 Series II MAZDA RX-8.

SYMPTOMS:

DRIVER EXPERIENCES 3rd to 4th GEAR LEVER 'POPPING OUT' WHILE DRIVING UNDER LOAD, OR COASTING...or...HARD TO ENGAGE GEAR...or...GRINDING...etc.

THIS ADJUSTING PROCEDURE SHOULD RECTIFY THE 3-4 GEAR LEVER ISSUES....

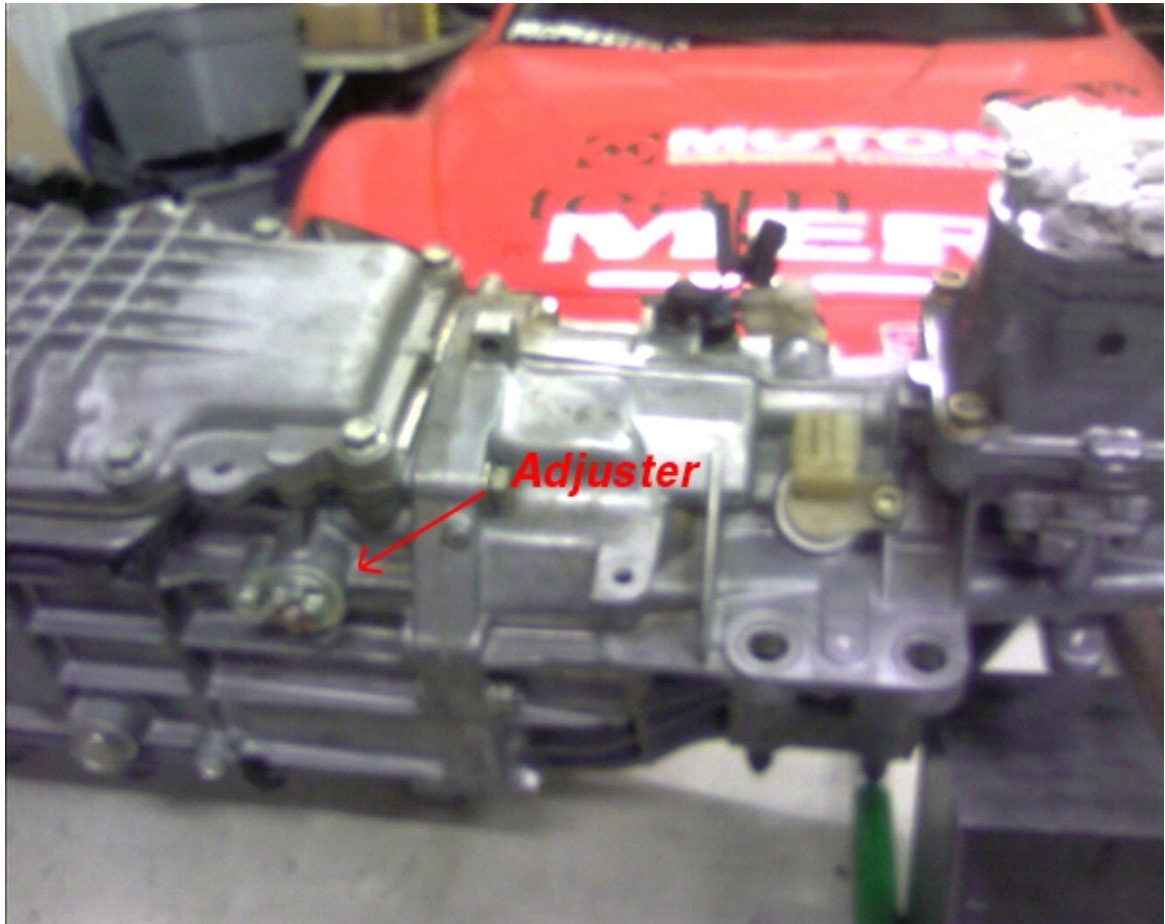

THIS SHOWS THE LOCATION OF THE **COUNTER LEVER SHAFT ADJUSTER** WHICH IS POSITIONED ON THE LEFT SIDE OF OUTER TRANSMISSION CASE.

It's not accessible from the top, you must get under car to adjust. It helps to have the entire car up on stands and to remove the lower cross-member brace to ease access.

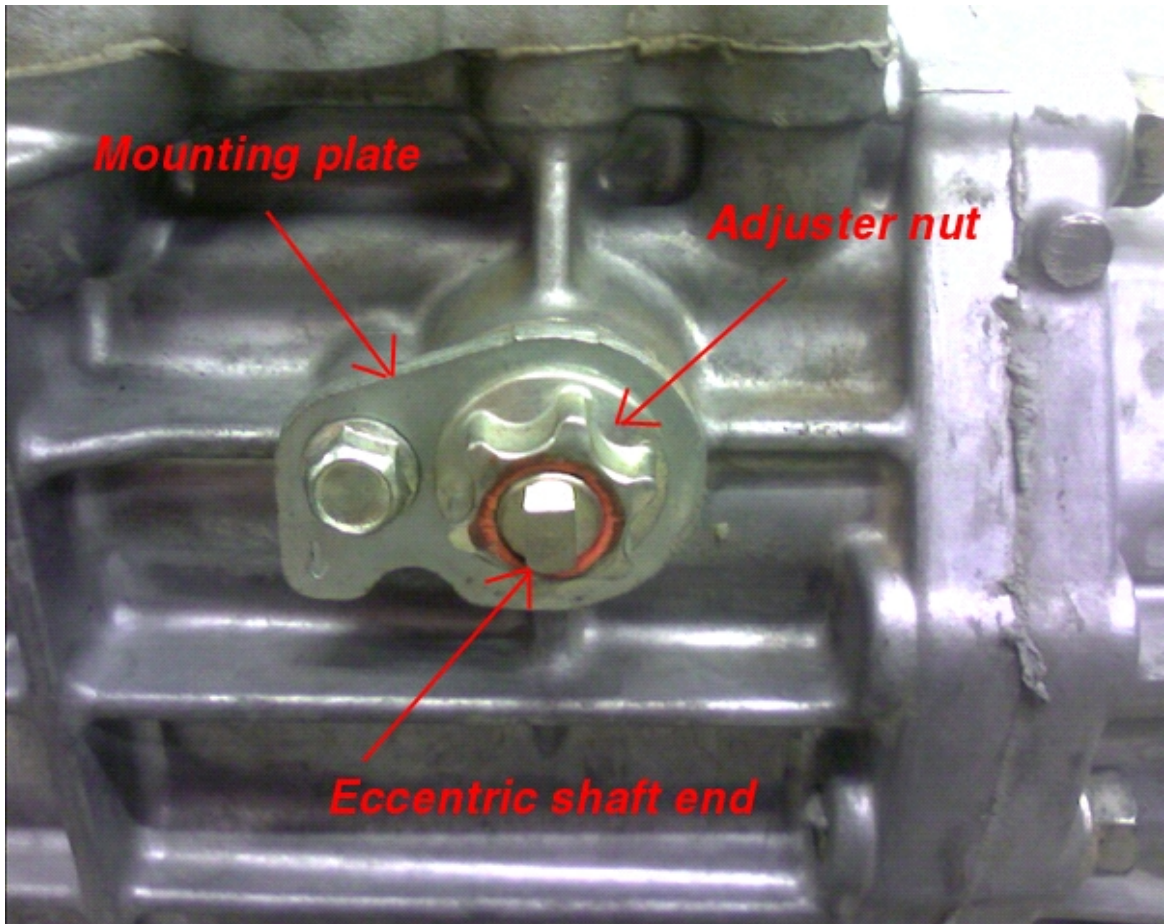

ADJUSTER CLOSE UP.

It's a 19mm 12-pt so you can use a box-end wrench to adjust it.

The eccentric shaft controls the position of the 3rd/4th extension lever that actuates the shift fork. By rotating it, you can change the fore/aft position of the lever versus the shifter mechanism.



INTERNAL PICTURE OF THE ADJUSTER.

The position of the adjuster in the transmission case with the top cover removed. You can see that the adjuster goes through to the 3rd/4th extension lever.

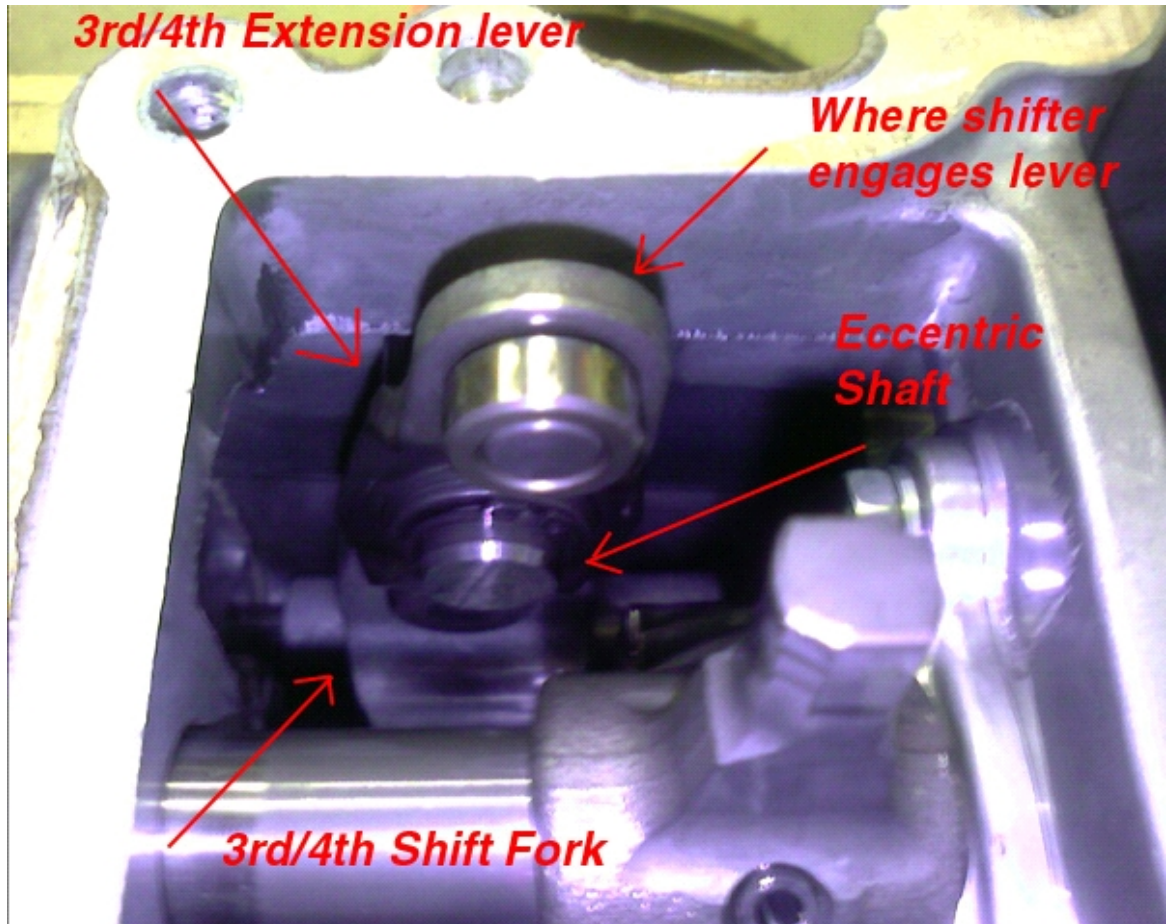

INTERNAL PICTURE OF SAME ADJUSTER.

Shows another position of the eccentric shaft, the 3rd/4th extension lever, and the actual shift fork (see below).

The 3rd/4th gears are on the counter-shaft in this transmission to make room for all the six gears, the extension lever is necessary to get the shift-motion down to the lower part of the case where these gears actually reside.



COUNTER LEVER SHAFT ADJUSTER AND 3/4 EXTENSION LEVER REMOVED.

As you can see, there is an o-ring to seal, and you can see where the eccentric portion of the shaft rides in a bore in the trans case.



ECCENTRIC SHAFT.

The eccentric shaft lobe portion of the shaft.



RECTIFICATION PROCEDURES*:

This is the actual problem and adjustment procedure.

After you remove the centre console and shift boots to expose the top of the shifter where it goes into the turret.

Basically (it helps if you have two people,) you move the adjuster nut back and forth until you equalize the gaps on the flats pictured...**extremely important to be accurate.**

Where the red lines are in the picture are the gaps in question.

You go back and forth between 3rd and 4th and you check in each gear.

You are finished when you have equalized the gaps front and rear.

The best way to do this is to 'hold' the shifter forward or back and have a helper move the adjuster.

The flats will touch when the adjustment is right, and there will be a gap when it is wrong.

Basically, take your time and experiment and play with it until it is correct.

You will see how it all works when doing actual adjustment.

Once the adjuster is correctly positioned, you can mark it with a sharpie or paint pen and then visually check adjuster and lock nut from time to time.

The adjuster can fall out of alignment over heavy periods of use particularly in circuit racing or track use, as there is no real locking off mechanism...some racers have fabricated aluminum external locking tabs for this adjuster.

I really doubt it will move in normal street driving provided it is correctly tightened.

CAUTION:

Chamfer side of e-shaft should point straight upward.

Apply Sealant to the threads of star lock nut.

FACTORY TIGHTENING SPECIFICATIONS:

Locknut tightening torque:

37.3—51.9 N·m {3.81—5.29 kgf·m, 27.6—38.2 ft·lbf}

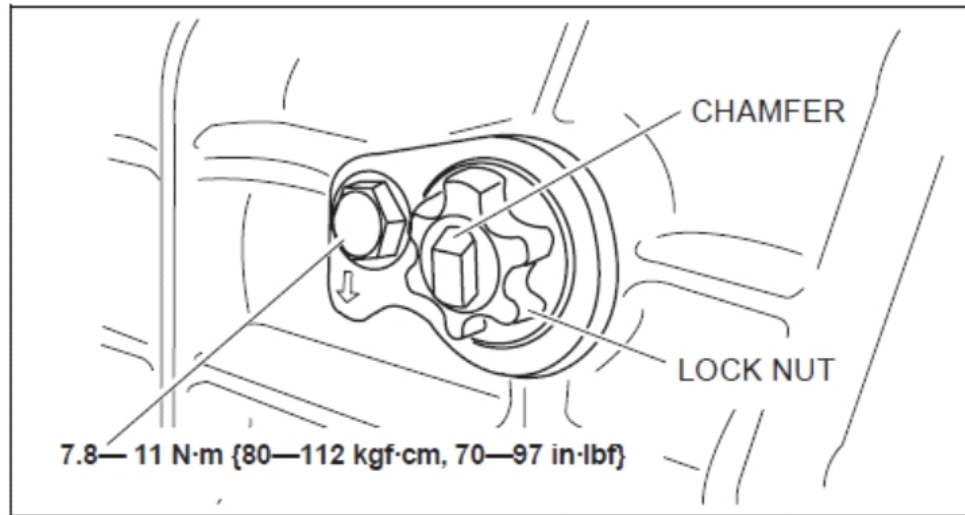

**THIS CONCLUDES THE 3/4 GEAR LEVER OR STICK ADJUSTMENT
PROCEDURE.**

...oooOOooo...

BELOW ARE SOME DETAILS ABOUT OTHER ISSUES FOUND IN RACING NC1
MIATA'S WITH MAZDA P66M TRANSMISSION, VIRTUALLY ALL HAVE BEEN
ADDRESSED BY MAZDA FROM LATE 2008 PRODUCTION, I HAVE INCLUDED
THIS HERE BELOW FOR INTEREST ONLY.



3/4 LEVER BUSHING.

Many racers renew the OEM stock installed square plastic bushings with either a round aluminum or locally fabricated brass square bush as the hard plastic bush tends to crush wear under extreme track conditions.

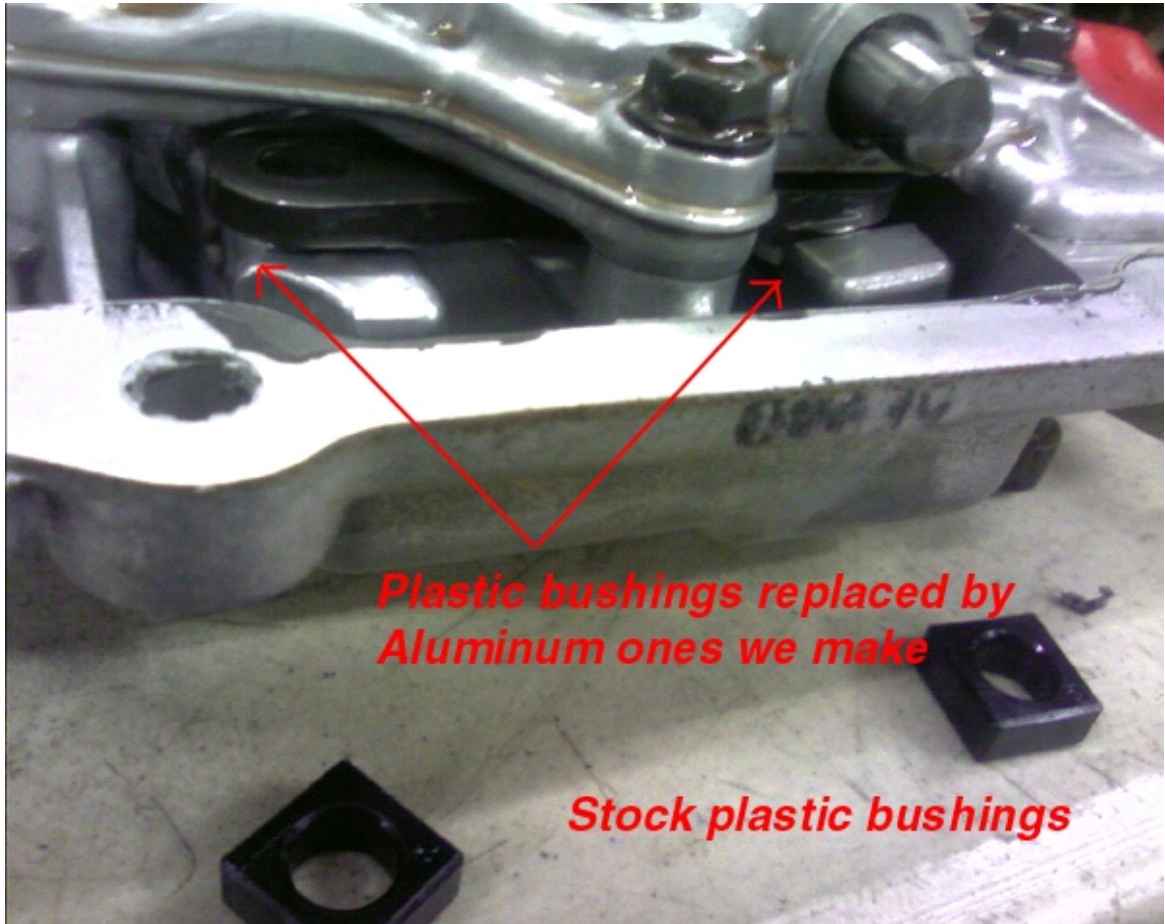

OEM BUSH REPLACEMENT WITH LOCAL FABRICATED ONES.



3/4 SHIFT HUB PICTURE.

This is a normal 3rd/4th shift hub which were know to give problems (cracking) on some early P66M Miata Transmissions. These Hubs have since been upgraded from February 2008 production.

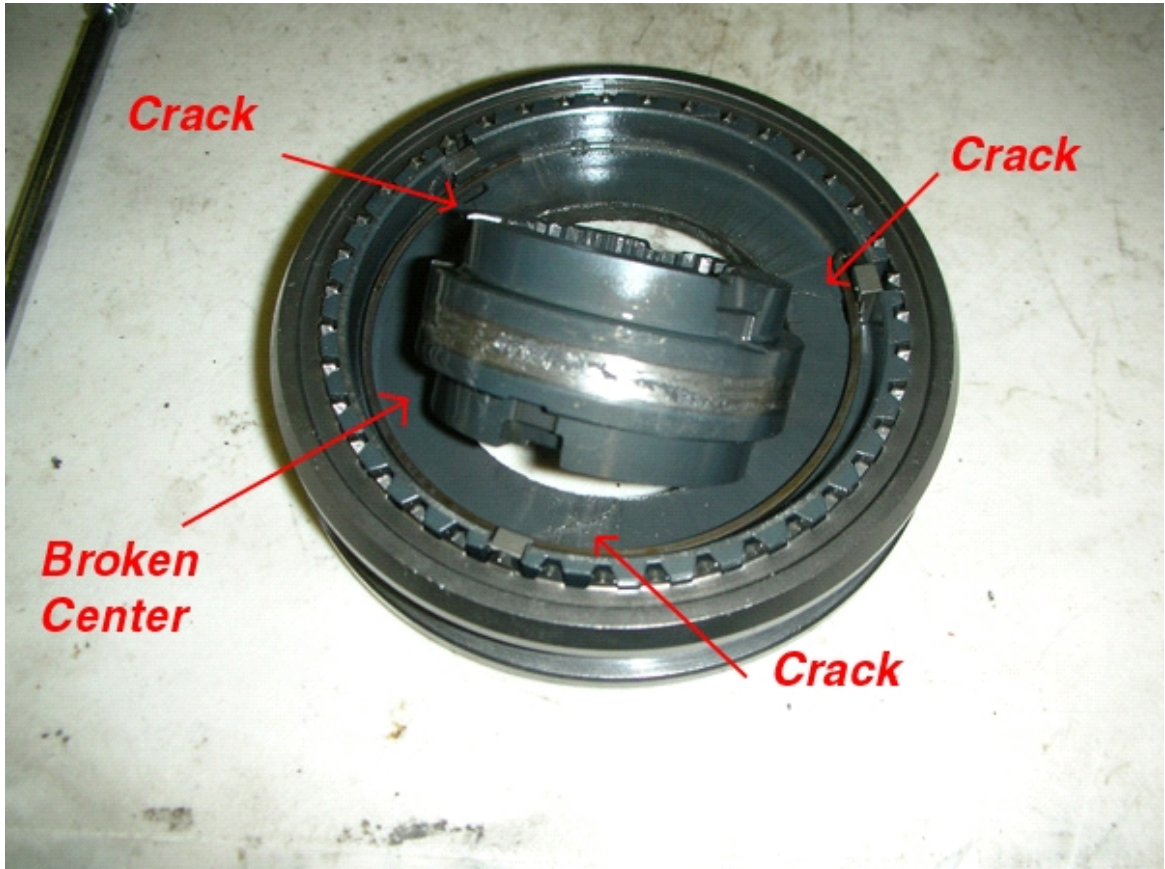

DAMAGED 3/4 HUB SET.

Remember this picture is taken from a racing P66M Miata Transmission. A normal domestic Miata/MX-5 should not normally see this type of wear damage.

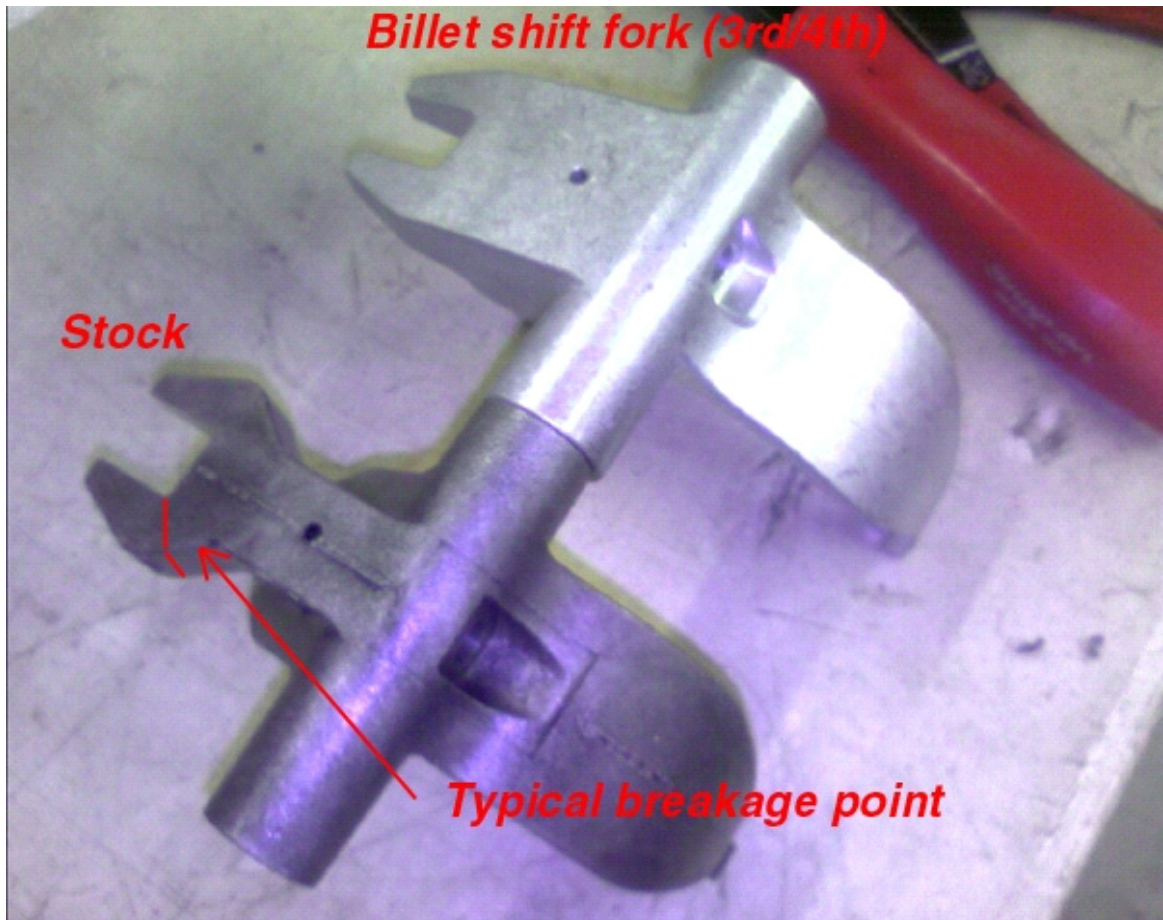

SHIFT FORKS HAS ALSO BEEN UPGRADED FROM February, 2008.

It is also worth noting that Mazda further upgraded the P66M Transmission for the Series II RX-8 with some heavier duty components to address the few shortcomings with the original NC1 MX-5 Miata P66M.

Since 2009 MY Miata MX-5 NC2 facelift (October 2008 production) Mazda has now included all the updated internals used in the Series II RX-8 to these 'heavier duty upgrades'.

All the internal parts are identical for both the 2009~ RX-8 and NC2 P66M 6MT, the actual trans differences are in the external transmission housing casings.

The method and procedures of 3/4 Shift Lever Throw Settings as detailed above has not changed for any P66M 6MT.

* Pictures shown above are a NC1 Miata MX-5 (from miata.net forum) with a P66M 6MT. **Note:** This 3/4 Shift Lever adjuster setting is identical for 2009~ Series II Mazda RX-8 also.

AGP

